

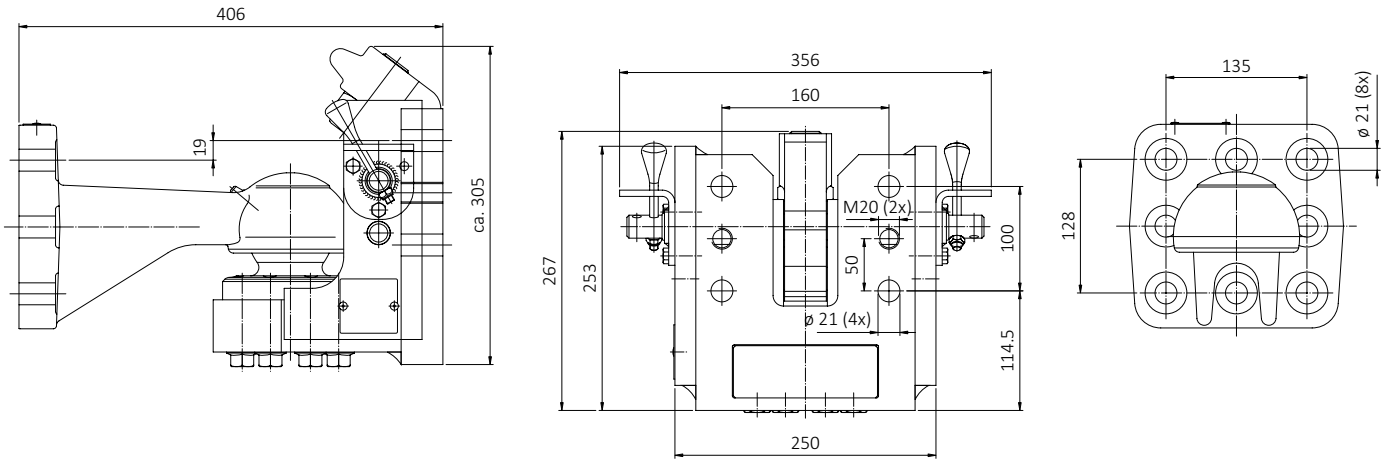





RO908 (Typ ROKU80)

Kugelkupplungssystem 80 mm für Fahrzeugtransporter

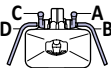
Ball coupling system 80 mm for car carrier



Technische Daten | Technical data

	 (mm)	 D (kN)	Dc (kN)	 S (kg)	V (kN)	 (kg)	 ECE	 ROE
RO908H61001*	160 x 100	140	140	1000/2500	90/75	71	E1 55R-01 2833	inkl. incl.
RO908H61501**	160 x 100	140	140	1000/2500	90/75	71	E1 55R-01 2833	inkl. incl.

* Schraubensatz 85 mm | Bolt kit 85 mm

** Schraubensatz 110 mm | Bolt kit 110 mm

RO908 (Typ ROKU80)

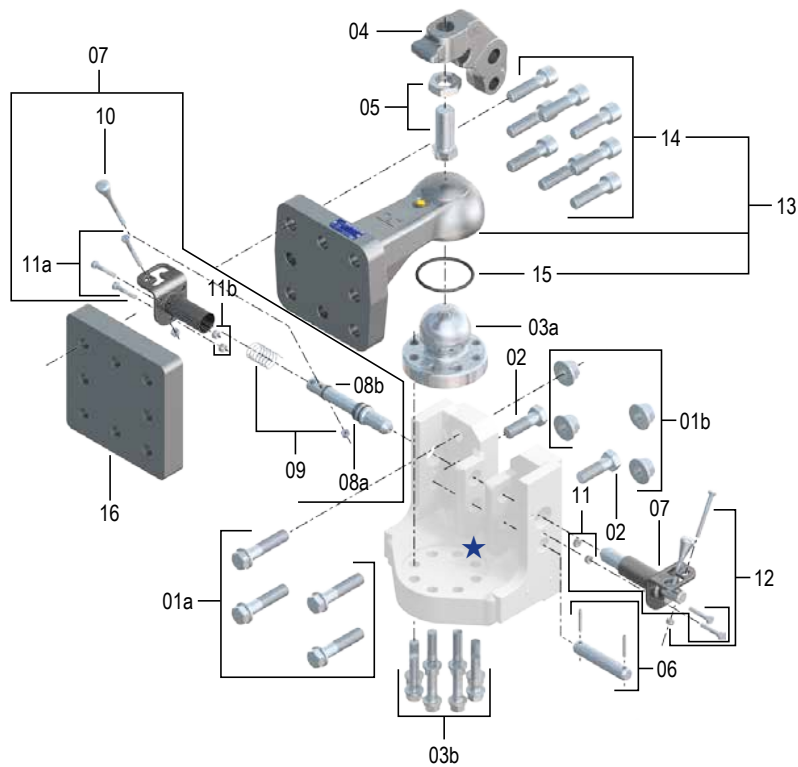

★ kein Ersatzteil
no spare part

Ersatzteile | Spare parts

Pos.	Beschreibung	Description	ROE	
01	Schraubensatz 85 mm	Screw set 85 mm	ROE71687	1
01	Schraubensatz 110 mm	Screw set 110 mm	ROE71760	1
02	Schraubensatz	Screw set	ROE30133-2	1
03	Kugelflanschsatz	Ball	ROE71685	1
04	Klinke	Latch	ROE63002	1
05	Schraubensatz	Screw set	ROE71684	1
06	Bolzensatz	Bolt set	ROE52563	1
07	Verriegelung kpl.	Safety system compl.	ROE71665	2
08	Dichtungssatz	Sealing set	ROE71683	2
09	Drehfeder links	Torsion spring left	ROE55286	2
10	Handhebel kpl.	Hand lever compl.	ROE50283	2
11	Schraubensatz	Screw set	ROE71682	2
12	Schraubensatz	Screw set	ROE71686	2
13	Flanschzugöse kpl.	Flange drawbar eye compl.	ROE57418	1
14	Schraubensatz	Screw set	ROE30485-8	1
15	O-Ring	O-ring	ROE25568	1
16	Anschweißplatte	Plate for welding	ROE59455	1